

SEIKO

SINCE 1881

INSTRUCTION MANUAL FOR WATCH CALIBRE

V172



WARNING



THIS PRODUCT CONTAINS A BUTTON BATTERY

If swallowed or placed inside any part of the body, the battery can cause severe or fatal injuries within 2 hours or less.

Button batteries are hazardous. Keep batteries out of reach of children.

If you think the battery may have been swallowed or placed inside any part of the body, seek immediate medical attention. Contact the Australian Poisons Information Centre immediately on 13 11 26 for 24/7 fast, expert advice.

V172 / V174 / V175 / V176

BSBV17C-A1902

SEIKO WATCH CORPORATION

Copyright©2019 by SEIKO WATCH CORPORATION

Printed in Japan

D-5

SEIKO

V172 / V174 / V175 / V176

SOLAR CHRONOGRAPH INSTRUCTIONS

日本語 **JA 1**

English **EN 1**

そのほかの言語の取扱説明書は、パソコンやスマートフォンから当社ホームページ内の「カスタマーサービス」>「取扱説明書ダウンロード」にアクセスいただき、ご覧ください。

Please refer to the Instruction Manuals of other languages by accessing "Customer Service"→ "Instruction" on our Website from PC or Smartphone.

Deutsch / Français / Italiano / Español /
Русский язык / العربية / Português /
简体中文 / 繁體中文 / 한국어 / ไทย



<https://www.seikowatches.com/>

**Thank you very much for choosing a SEIKO watch.
For proper and safe use of your SEIKO watch,
please read carefully the instructions in this
booklet before using it.**

Keep this manual handy for easy reference.

- * Length adjustment service for metallic bands is available at the retailer from whom the watch was purchased. If you cannot have your watch repaired by the retailer from whom the watch was purchased because you received the watch as a gift, or you moved to a distant place, please contact SEIKO CUSTOMER SERVICE CENTER. The service may also be available on a chargeable basis at other retailers, however, some retailers may not undertake the service.
- * If your watch has a protective film for preventing scratches, make sure to peel it off before using the watch. If the watch is used with the film on it, dirt, sweat, dust, or moisture may be attached to the film and may cause rust.

EN 1

CONTENTS

1 HOW TO USE

Handling cautions	4
Characteristics	8
Names of the parts and functions	9
V172: Equipped with a stopwatch and alarm	10
V172: Equipped with a stopwatch, alarm and compass	11
V174: Equipped with a stopwatch, alarm and 24-hour hand	12
V175: Equipped with a stopwatch and 24-hour hand	13
V176: Equipped with a stopwatch	14
Crown	15
Compass (Only for models with the compass inner ring)	16

2 HOW TO SET THE TIME AND DATE

How to set the time and date	17
How to set the time and date	17
Manual date adjustment at the end of the month	21

3 HOW TO USE THE STOPWATCH

Stopwatch function	22
The names of the parts and functions of the stopwatch (V172, V174)	22
The names of the parts and functions of the stopwatch (V175)	23
The names of the parts and functions of the stopwatch (V176)	24
Before using the stopwatch	26
How to use the stopwatch	28
How to use the tachymeter	32

4 HOW TO USE THE ALARM

How to use the alarm (V172, V174)	34
How to set the alarm time	35
How to stop the alarm	36
How to disengage the set alarm time	36
Alarm sound test	36

5 SOLAR CHARGING FUNCTION

Charging the battery	37
How to charge the battery	37
Guide to charging times	38
About energy	39

6 TO PRESERVE THE QUALITY OF YOUR WATCH

Power Source	40
Daily care	42
Performance and type	43
Lumibrite	44
Water resistant performance	45
Magnetic resistant performance	46

Band	48
How to use tri-fold type clasp for leather band (Special clasps)	50
After sales service	56

7 TROUBLESHOOTING

Adjusting the preliminary position of the stopwatch hands	58
Adjusting the preliminary position of the stopwatch 1/5-second and minute hands (V172, V174, V175)	59
Adjusting the preliminary position of the stopwatch 1/20-second, second and minute hands (V176)	63
Troubleshooting	67
If the hands fail to move or move abnormally even after recharging	70
Resetting the built-in IC	70

8 SPECIFICATIONS

Specifications	72
----------------------	----

EN 2

EN 3

Handling cautions

⚠ WARNING

Please note that there is a risk of serious consequences such as severe injury if the following safety regulations are not strictly observed.

Immediately stop wearing the watch in following cases:

- If the watch body or band becomes edged by corrosion etc.
- If the pins protrude from the band.
- * Immediately consult the retailer from whom the watch was purchased or SEIKO CUSTOMER SERVICE CENTER.

Keep the watch and accessories out of the reach of babies and children.

Care should be taken to prevent a baby or a child accidentally swallowing the accessories. If a baby or child swallows the battery or accessories, immediately consult a doctor, as it will be harmful to the health of the baby or child.

Do not remove the secondary battery from the watch.

- * About the secondary battery → Power Source → P.40
- Replacement of the secondary battery requires professional knowledge and skill. Please ask the retailer from whom the watch was purchased for replacement of the secondary battery.
- Installation of an ordinary silver oxide battery can generate heat that can cause bursting and ignition.

⚠ WARNING



Do not use the watch in scuba diving or saturation diving.

The various tightened inspections under simulated harsh environment, which are usually required for watches designed for scuba diving or saturation diving, have not been conducted on the water resistant watch with the BAR (barometric pressure) display. For diving, use watches specifically designed for diving.

⚠ CAUTION



Do not pour running water directly from faucet.

The water pressure of tap water from a faucet is high enough to degrade the water resistant performance of a water resistant watch for everyday life.

⚠ CAUTION

Please note that there is a risk of minor injury or material damage if the following safety regulations are not strictly observed.

Avoid the following places for wearing or keeping the watch:

- Places where volatile agents (cosmetics such as polish remover, bug repellent, thinners etc.) are vaporizing
- Places where the temperature drops below 5°C or rises above 35°C for a long time
- Places affected by strong magnetism or static electricity
- Places affected by strong vibrations
- Places of high humidity
- Dusty places

If you observe any allergic symptoms or skin irritation

Stop wearing the watch immediately and consult a specialist such as a dermatologist or an allergist.

Other cautions

- For adjusting the length of the metallic band, specialized knowledge and expertise are necessary. Therefore, in such a case, contact the retailer from whom the watch was purchased. If you attempt to adjust the metallic band, injury may occur to your hand or fingers, or parts of the band may be lost.
- Do not disassemble or tamper with the watch.
- Keep the watch out of the reach of babies and children. Extra care should be taken to avoid risks of any injury or allergic rash or itching that may be caused when they touch the watch.
- When disposing of used batteries, follow the instructions of your local authorities.
- If your watch is of the fob or pendant type, the strap or chain attached to the watch may damage your clothes, or injure the hand, neck, or other parts of your body.

⚠ CAUTION

Please note that there is a risk of minor injury or material damage if the following safety regulations are not strictly observed.



Do not turn or pull out the crown when the watch is wet.

Water may get inside of the watch.

* If the inner surface of the glass is clouded with condensation or water droplets appear inside of the watch for a long time, the water resistant performance of the watch is deteriorated. Immediately consult the retailer from whom the watch was purchased or SEIKO CUSTOMER SERVICE CENTER.



Do not leave moisture, sweat and dirt on the watch for a long time.

Be aware of a risk that a water resistant watch may lessen its water resistant performance because of deterioration of the adhesive on the glass or gasket, or the development of rust on stainless steel.



Do not wear the watch while taking a bath or a sauna.

Steam, soap or some components of a hot spring may accelerate the deterioration of water resistant performance of the watch.

Characteristics

This solar watch is equipped with a stopwatch function.

- A full-scale stopwatch, which can measure in 1/5-second increments (V172, V174, V175) or 1/20-second increments (V176) with the center hand, is equipped.
- A solar cell under the dial converts any form of light into “electrical energy” to operate the watch.

* “Chronograph” means a watch with a stopwatch function.

- **Stopwatch function**..... The stopwatch can measure up to 60 minutes in 1/5-second increments (V172, V174, V175) or 1/20-second increments (V176). After measuring 60 minutes, the stopwatch will automatically stop.
→ P.22
- **Alarm function**..... The single-time alarm can be set to sound only once at a designated time.
→ P.34
The alarm time can be set in one-minute increments to the time until 11 hours 59 minutes is reached.
(Only available for V172 and V174)
- **Solar Charging Function**..... The watch charges by converting light that shines on the solar panel on the dial into electrical energy. After the battery is fully charged, the watch will operate for about six months even if the dial is not exposed to light.
→ P.37

EN 8

V172: Equipped with a stopwatch and alarm

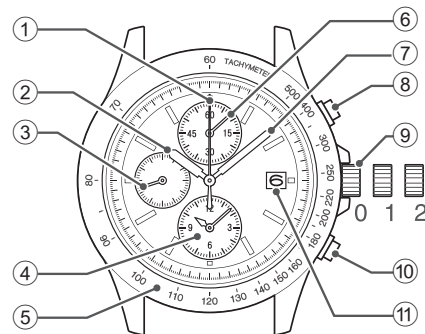

- ① **Stopwatch 1/5-second hand**
- ② **Hour hand**
- ③ **Seconds hand**
- ④ **Small alarm display**
→ P.34
- ⑤ **Tachymeter**
→ P.32
- ⑥ **Stopwatch minute hand**
- ⑦ **Minute hand**
- ⑧ **Button A**
- ⑨ **Crown**
 - Normal position (not locked): Stopwatch
 - First click position: Date setting, alarm time setting
 - Second click position: Setting the time, setting the stopwatch hands to preliminary position, and performing a system reset
- ⑩ **Button B**
- ⑪ **Date**

* Some models may not have a tachymeter.

EN 10

Names of the parts and functions

Refer to the page corresponding to the caliber of your watch.

The case back shows the caliber and performance of your watch.
“Performance and type” → P.43

* The caliber number shows your watch type.

Caliber number	V172	V174	V175	V176
Reference page (Names of the parts and functions)	P.10, 11	P.12	P.13	P.14
Stopwatch function	Measures in 1/5-second increments			Measures in 1/20 second increments
Alarm function	Yes	Yes	No	No
24-hour display	No	Yes	Yes	No

EN 9

V172: Equipped with a stopwatch, alarm and compass

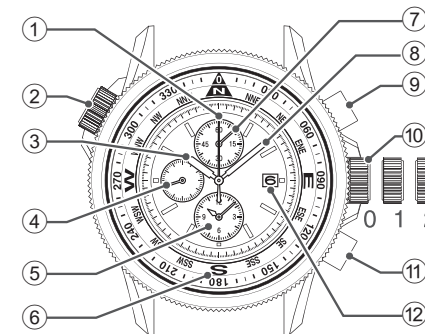

- ① **Stopwatch 1/5-second hand**
- ② **Inner ring**
- ③ **Hour hand**
- ④ **Seconds hand**
- ⑤ **Small alarm display**
→ P.34
- ⑥ **Compass**
→ P.16
- ⑦ **Stopwatch minute hand**
- ⑧ **Minute hand**
- ⑨ **Button A**
- ⑩ **Crown**
 - Normal position (not locked): Stopwatch
 - First click position: Date setting, alarm time setting
 - Second click position: Setting the time, setting the stopwatch hands to preliminary position, and performing a system reset
- ⑪ **Button B**
- ⑫ **Date**

EN 11

■ V174: Equipped with a stopwatch, alarm and 24-hour hand

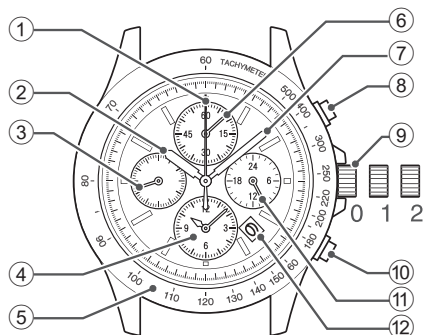

- ① Stopwatch 1/5-second hand
- ② Hour hand
- ③ Seconds hand
- ④ Small alarm display
→ P.34
- ⑤ Tachymeter
→ P.32
- ⑥ Stopwatch minute hand
- ⑦ Minute hand
- ⑧ Button A
- ⑨ Crown
 - Normal position (not locked): Stopwatch
 - First click position: Date setting, alarm time setting
 - Second click position: Setting the time, setting the stopwatch hands to preliminary position, and performing a system reset
- ⑩ Button B
- ⑪ 24-hour hand
- ⑫ Date

* Some models may not have a tachymeter.

■ V175: Equipped with a stopwatch and 24-hour hand

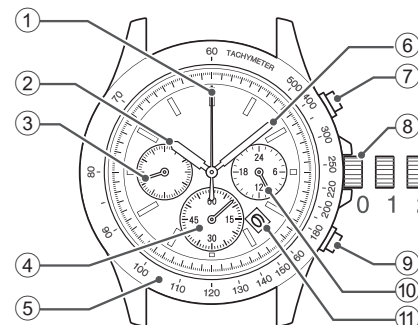

- ① Stopwatch 1/5-second hand
- ② Hour hand
- ③ Seconds hand
- ④ Stopwatch minute hand
- ⑤ Tachymeter
→ P.32
- ⑥ Minute hand
- ⑦ Button A
- ⑧ Crown
 - Normal position (not locked): Stopwatch
 - First click position: Date setting
 - Second click position: Setting the time, setting the stopwatch hands to preliminary position, and performing a system reset
- ⑨ Button B
- ⑩ 24-hour hand
- ⑪ Date

* Some models may not have a tachymeter.

■ V176: Equipped with a stopwatch

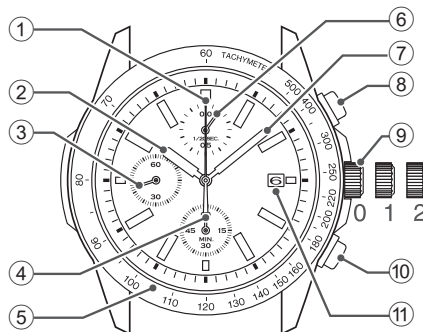

- ① Stopwatch second hand
- ② Hour hand
- ③ Seconds hand
- ④ Stopwatch minute hand
- ⑤ Tachymeter
→ P.32
- ⑥ Stopwatch 1/20-second hand
- ⑦ Minute hand
- ⑧ Button A
- ⑨ Crown
 - Normal position (not locked): Stopwatch
 - First click position: Date setting
 - Second click position: Setting the time, setting the stopwatch hands to preliminary position, and performing a system reset
- ⑩ Button B
- ⑪ Date

* Some models may not have a tachymeter.

Crown

There are two types of crowns, a normal crown and a screw down crown. Please check the type of the crown of your watch.

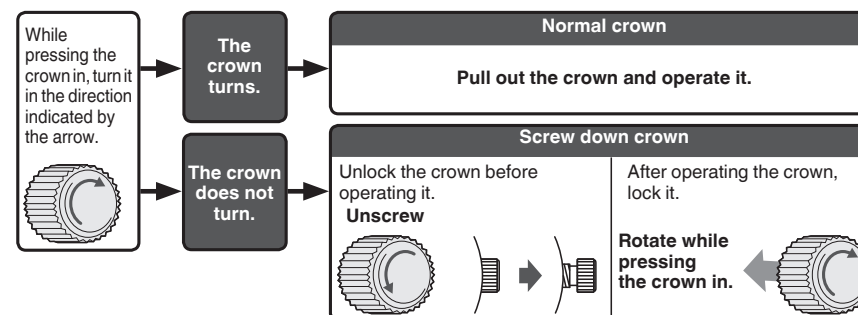

- * By locking the crown by screw, a screw down crown can prevent malfunction and increase water resistance.
- * Be careful not to screw the crown in by force as it may damage the slots of the crown.

1 Compass (Only for models with the compass inner ring)

HOW TO USE

The compass is functional only within the northern hemisphere, and it may not function properly at lower latitudes (South of the Tropic of Cancer) depending on the season of the year. Please use the compass in places where the direction of the sun can be determined.

While keeping the dial level, point the hour hand towards the sun. The direction of south is indicated by the middle point of the arc between the 12 o'clock marker and the time indicated by the hour hand.

* The compass is so designed to provide only a rough indication of directions, and should not be used where accuracy is critical.

● For models with the rotating compass inner ring

Turn the crown for the rotating compass inner ring to set "S" on the rotating compass inner ring to the direction of the south.

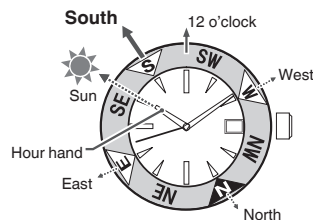

EN 16

2

HOW TO SET THE TIME AND DATE

3 Pull out the crown to the first click.

The seconds hand continues moving.

* For models with screw down crown, please unlock the crown before operating it.

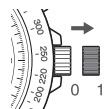

Pull out the crown to the first click

4 The date can be set by turning the crown.

Turn it until the previous day's date appears.

Ex.) To display the date as "6," then set this to "5." Turn the crown to the right (clockwise) to set the date.

EN 18

How to set the time and date

■ How to set the time and date

* When setting the date only, refer to "Manual date adjustment at the end of the month" → P.21.

1 Make sure that the watch is working.

Check that the seconds hand is moving at one-second intervals.

If the seconds hand is moving at two-second intervals or the seconds hand has stopped, charge the watch by exposing the dial of the watch to light. "Charging the battery" → P.37

2 Check that the watch hands are not displaying any time between 9 p.m. and 1 a.m.

If a time between 9 p.m. and 1 a.m. is being displayed, pull the crown to the second click, advance the hands beyond the 1 a.m. position, and push the crown back in.

* This procedure is required to ensure the proper engagement of the date driving wheel.

* Each time the hour hand makes two full rotations by turning the crown, the date is adjusted one day. While turning the crown, the date changes at exactly midnight. When setting the hour hand, be sure that AM/PM is set correctly (For the models V174 and V175, the 24-hour hand can be used as an AM/PM indicator. "Names of the parts and functions" → P.12, 13)

2

HOW TO SET THE TIME AND DATE

EN 17

5 Pull out the crown to the second click and set the time.

Pull out the crown to the second click when the seconds hand is at the 12 o'clock position; the seconds hand stops on the spot.

Turn the crown to advance the hands until the date changes to the next. The time is now set for the A.M. period. Advance the hands to set the correct time.

* For models V174 and V175, the 24-hour hand can be used as an AM/PM indicator.

* In order to set the time accurately, turn the minute hand 4 to 5 minutes ahead and then return it to the correct time.

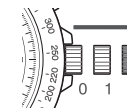

● If you own model V172 or V174:

It is recommended to set the minute hand two minutes ahead of the correct time (proceed to operation of the procedure 6).

● If you own model V175 or V176:

Continue to procedure 7.

* If you do not know the caliber number of your watch: The caliber number shows your watch type. "Performance and type" → P.43

2

HOW TO SET THE TIME AND DATE

EN 19

6 Press button B to set the alarm time to the same time as the main time (only for models V172 and V174).

If button B is kept pressed, the alarm hands advance quickly.

* Alarm time can be set on a 12-hour basis.

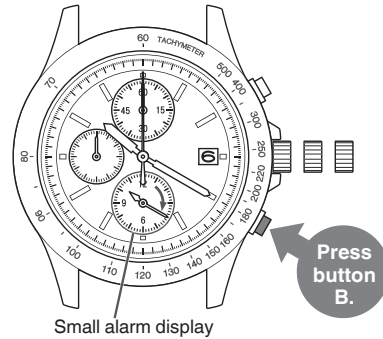

7 Push the crown back in to the normal position in accordance with a time signal.

The seconds hand immediately starts moving.

* The telephone time signal service is helpful for setting the seconds hand exactly.

* For models with screw down crown, please be sure to lock the crown after operating it.

Manual date adjustment at the end of the month

It is necessary to adjust the date at the end of February and 30-day months.

Ex.) To adjust the date in the A.M. period on the first day of a month following a 30-day month
The watch displays "31" instead of "1." Pull out the crown to the first click.

Turn the crown clockwise to set the date to "1" and then push the crown back in to the normal position.

* For models with screw down crown, please be sure to lock the crown after operating it.

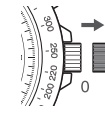

Pull out the crown to the first click

CAUTION

- Avoid amending the date when the watch is displaying between 9 PM and 1 AM. Doing so may cause damage.

Stopwatch function

The stopwatch can measure up to 60 minutes in 1/5-second increments (V172, V174, V175) or 1/20-second increments (V176). After measuring 60 minutes, the stopwatch hands will automatically stop at the 0 minute 0 second position.

The names of the parts and functions of the stopwatch (V172, V174)



- ① **Stopwatch 1/5-second hand**
moves in 1/5-second increments
- ② **Stopwatch minute hand**
moves in one-minute increments
- ③ **Button A**
Start/Stop
- ④ **Button B**
Split/Reset
- ⑤ **Tachymeter**
→ P.32
* The position of the tachymeter display may differ depending on the design of the model.
* Some models may not have a tachymeter.

The names of the parts and functions of the stopwatch (V175)



- ① **Stopwatch 1/5-second hand**
moves in 1/5-second increments
- ② **Button A**
Start/Stop
- ③ **Button B**
Split/Reset
- ④ **Stopwatch minute hand**
moves in one-minute increments
- ⑤ **Tachymeter**
→ P.32
* The position of the tachymeter display may differ depending on the design of the model.
* Some models may not have a tachymeter.

■ The names of the parts and functions of the stopwatch (V176)

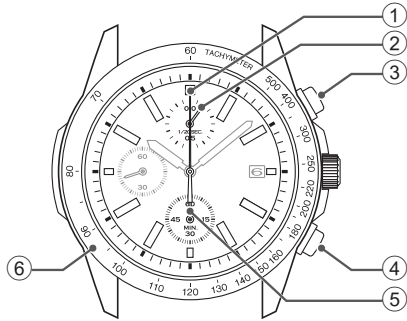

- ① **Stopwatch second hand**
moves in one-second increments
- ② **Stopwatch 1/20-second hand**
moves in 1/20-second increments
- ③ **Button A**
Start/Stop
- ④ **Button B**
Split/Reset
- ⑤ **Stopwatch minute hand**
moves in one-minute increments
- ⑥ **Tachymeter**
→ P.32
* The position of the tachymeter display may differ depending on the design of the model.
* Some models may not have a tachymeter.

<Notes on the movement of the stopwatch 1/20 second hand>

- After the stopwatch is started, the stopwatch 1/20 second hand moves for about 1 minute and automatically stops at "0" position.
- When split time is measured or the measurement is stopped, it moves to indicate the elapsed 1/20 seconds.
- After split time is released or the measurement is restarted, it moves for about 1 minute and stops automatically.
- In the same manner, if the stopwatch is stopped and restarted repeatedly or split time is measured and released repeatedly, it will keep moving for maximum 2 minutes after the last operation.

■ Before using the stopwatch

Before using the stopwatch, reset the stopwatch to make sure that the stopwatch hands are reset to the 0 minute 0 second position.

Refer to the following procedure for resetting the stopwatch.

- * When the seconds hand is moving at two-second intervals, the stopwatch cannot be operated.
"About energy" → P.39

• How to reset the stopwatch

- * The stopwatch can be operated when the crown is at the normal position.

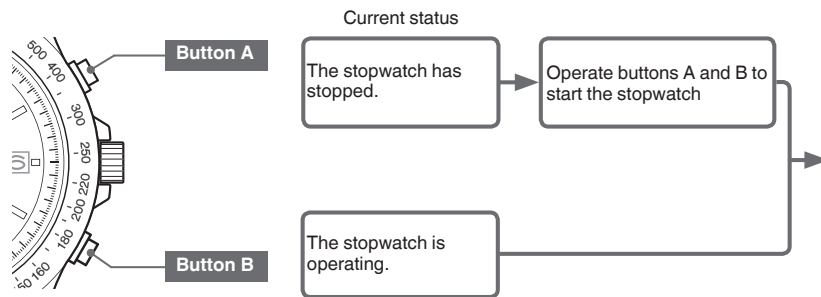

If any of the stopwatch hands do not return to 0 minute 0 second when the stopwatch is reset, set the stopwatch hands to the preliminary hand position.

"Adjusting the preliminary position of the stopwatch hands" → P.58

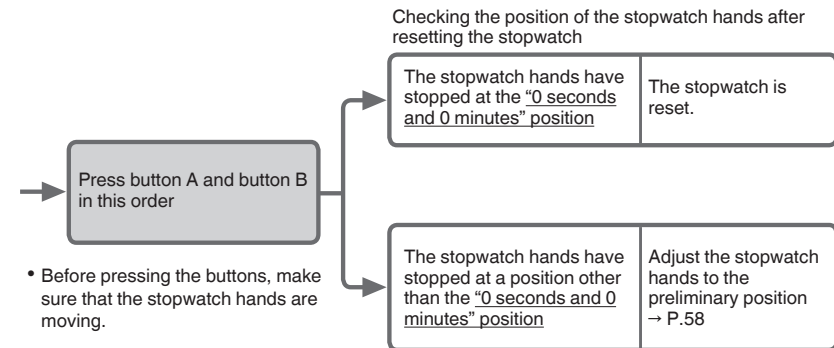

- Before pressing the buttons, make sure that the stopwatch hands are moving.

How to use the stopwatch

* When the seconds hand is moving at two-second intervals, the stopwatch cannot be operated.
 "About energy" → P.39

• **Standard measurement Ex. 5,000 meters running**

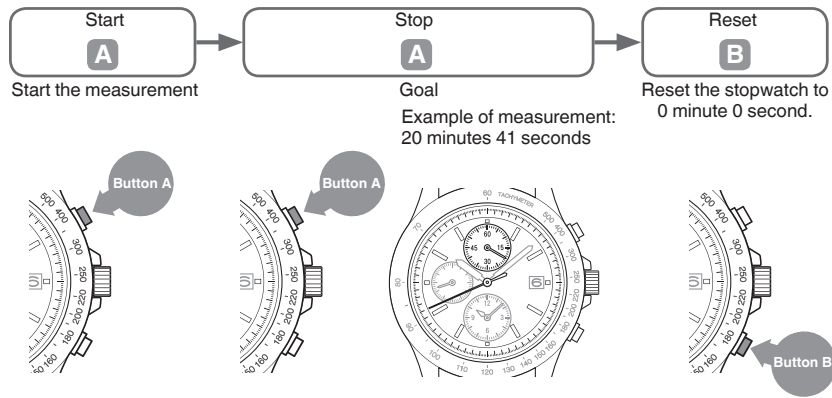

• **Split time (intermediate elapsed time) measurement Ex. 5,000 meters running**

* "Split time" is the time that has elapsed from the start of an activity to any given stage.

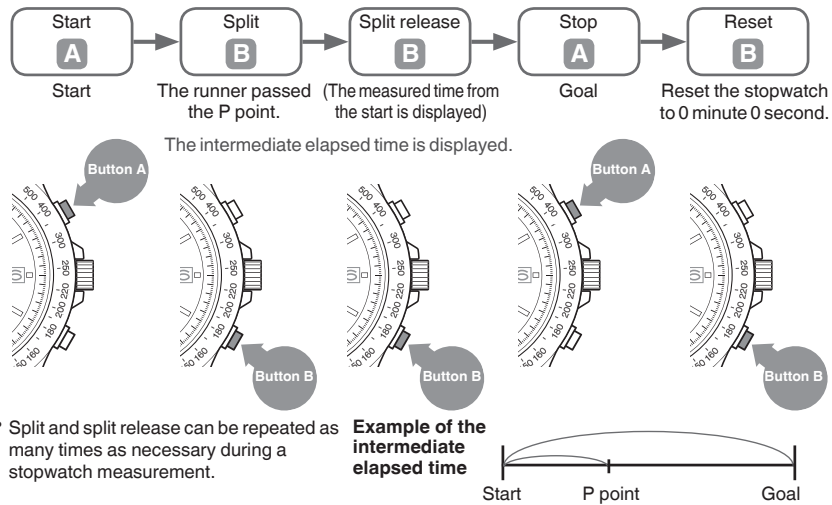

• Split and split release can be repeated as many times as necessary during a stopwatch measurement.

• **Accumulated elapsed time measurement Ex. Measuring the time for a soccer match**

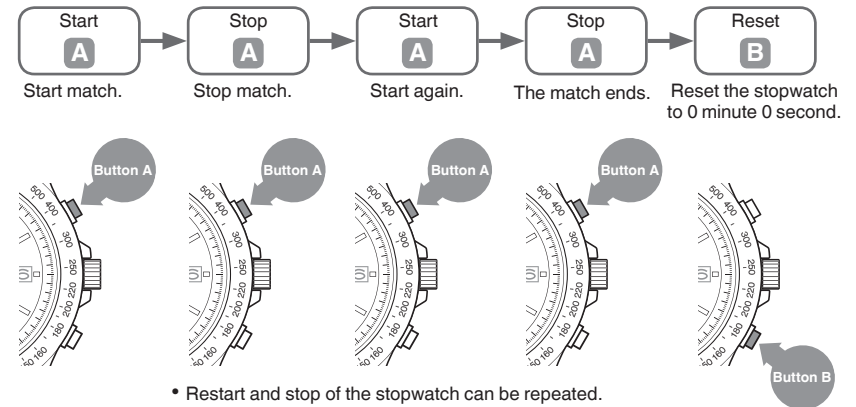

• **Measurement of two competitors**

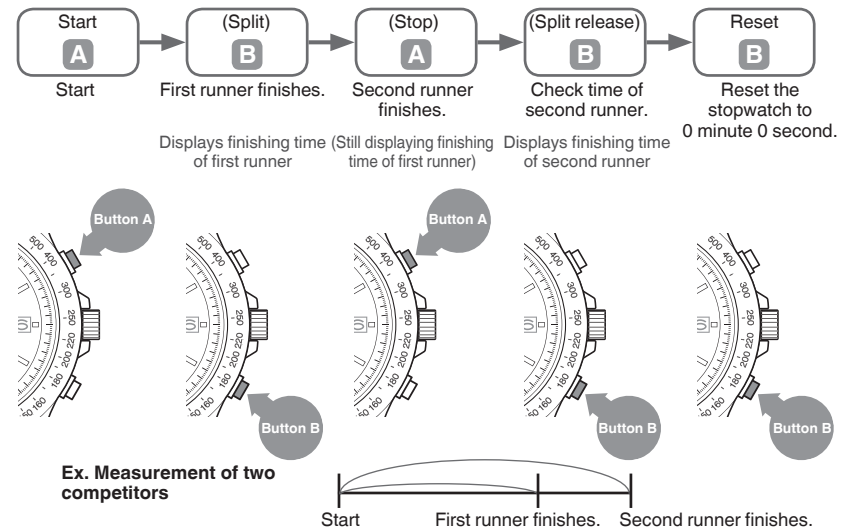

How to use the tachymeter

The numbers on the tachymeter scale can be read to determine how many seconds it takes to run 1 km or to measure the time required to complete 1 job.

3

HOW TO USE THE STOPWATCH

- How to measure kilometers / hour

- 1 Measure the time (within 1 minute) it takes to run 1 km.
- 2 Read the number on the tachymeter scale that the stopwatch 1/5-second hand (V172, V174, V175) or seconds hand (V176) is pointing to.

Ex. : If it takes 45 seconds to run 1 km...80 km/h

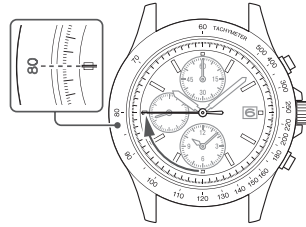

EN 32

- How to measure the hourly rate of operation

- 1 Measure the time (within 1 minute) required to complete 1 job.
- 2 Read the number on the tachymeter scale that the stopwatch 1/5-second hand (V172, V174, V175) or seconds hand (V176) is pointing to.

Ex. : If it takes 20 seconds to complete one product...180 products/hour

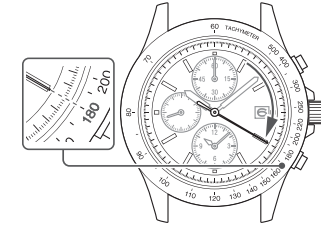

3

HOW TO USE THE STOPWATCH

How to use the alarm (V172, V174)

The single-time alarm can be set to sound only once at a designated time.
When the time of the main time reaches the designated alarm time, the alarm sounds.
The alarm time can be set in one-minute increments within the coming 11 hours 59 minutes.

4

HOW TO USE THE ALARM



① Minute hand

② Hour hand

③ Small alarm display

When the alarm time is set:
the designated alarm time is displayed.

When the alarm time is not set:
current time (same as the main time) is displayed.

* When the seconds hand is moving at two-second intervals, the alarm does not sound at the set alarm time. And alarm time cannot be set. "About energy" → (P.39)

EN 34

How to set the alarm time

1 Pull out the crown to the first click.

- The watch continues operating.
- * For models with screw down crown, please unlock the crown before operating it.

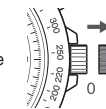

Pull out the crown to the first click

2 Press button B to set the alarm time.

If button B is kept pressed, the alarm hands are fast forwarded.

- * If the alarm hands advance more than the desired alarm time, continue pressing button B to advance the hand to set the desired alarm time.
- * If button B is kept pressed until the alarm hands point to the same time as the main time, the alarm hands stop and the alarm is disengaged.

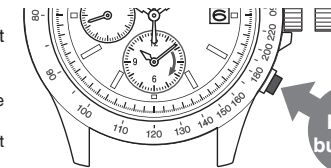

3 Push the crown back in to the normal position.

- * For models with screw down crown, please be sure to lock the crown after operating it.

4

HOW TO USE THE ALARM

EN 35

How to stop the alarm

- The alarm sounds for 20 seconds at the set alarm time.
- For stopping the sounding alarm, press button A or B.
- * While the stopwatch hands are moving, the alarm sounds differently than the normal alarm sound. This is not a malfunction.
- * When the alarm is sounding, if button A or B is pressed, the alarm stops sounding, but the stopwatch cannot be operated. After the alarm sound stops, the stopwatch can be operated.

How to disengage the set alarm time

- If you want to disengage the set alarm time, reset the alarm time to the same time as the main time.
→ P.35

Alarm sound test

- To test the alarm sound, pull out the crown to the first click, and then long press button A (for about 4 seconds). The alarm sounds while the button A is kept pressed.
- * When you finish the sound test, push the crown back in to the normal position. For models with screw down crown, please be sure to lock the crown after operating it. → P.15

Guide to charging times

Charge the watch using the times below as a guide.

Illuminance lx (LUX)	Light source	Condition (Example)	Time required for fully charging the watch	Time required for charging the watch to start moving at one-second intervals	Time required for charging the watch to last for 1 day
700	Fluorescent light	General offices	-	60 hours	2.5 hours
3,000	Fluorescent light	30 W 20 cm	110 hours	13 hours	33 minutes
10,000	Fluorescent light	30 W 5 cm	30 hours	3.5 hours	9 minutes
10,000	Sunlight	Cloudy day	30 hours	3.5 hours	9 minutes
100,000	Sunlight	Sunny day (Under the direct sunlight on a summer day)	5 hours	36 minutes	2 minutes

The figures of "Time required for charging the watch to start moving at one-second intervals" are estimations of time required to charge the stopped watch by exposing it to light until it moves at steady one-second intervals. Even if the watch is partially charged for a shorter period, the watch will resume one-second interval movement. However, it may shortly return to two-second interval movement. Use the charging time in this column as a rough guide for sufficient charging time.

* The required charging time slightly varies depending on the model of the watch.

Charging the battery

How to charge the battery

Expose the dial to light to charge the watch.

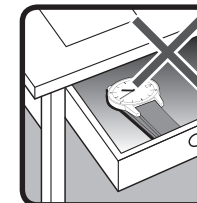
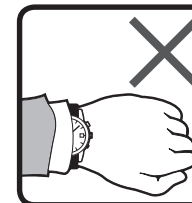

To ensure optimal performance of the watch, make sure that the watch is kept sufficiently charged at all times.

Under the following situations, the energy of the watch is likely to be depleted, resulting in stoppage of the watch:

- The watch is concealed under a sleeve.
- The watch is used or stored under conditions where it cannot be exposed to light for a long time.

* Be careful to make sure that the watch does not get hot when it is charging. (The operating temperature range is -10°C to +60°C.)

* When you first start using the watch or starting it after it stopped due to a lack of charge, charge the watch sufficiently using the table on P.38 as a guide.

About energy

When the energy stored in the watch is running down, the seconds hand starts moving at two-second intervals.

If the energy runs out, the watch will stop.

If the seconds hand starts moving at two-second intervals, fully charge the watch.

How to charge the battery → P.37

Guide to charging times → P.38

- Stopwatch cannot be operated while the seconds hand is moving at two-second intervals (this is not a malfunction).
- If the seconds hand starts moving at two-second intervals while the stopwatch is counting, the stopwatch hands return to 0 minute 0 second to reset the measurement.
- Alarm time setting cannot be carried out while the seconds hand is moving at two-second intervals.
- If the set alarm time is reached while the seconds hand is moving at two-second intervals, the alarm does not sound (the set alarm time will be disengaged).

Power Source

The battery used in this watch is a special secondary battery, which is different from ordinary batteries. Unlike an ordinary silver oxide battery, the secondary battery does not require periodic replacement.

The capacity or charging efficiency may gradually lower due to long-term use or operating environment. In addition, long-term use may shorten the charge duration due to wear, contamination, lubricant deterioration of mechanical parts, etc. Request repair when the performance lowers.

⚠ WARNING

■ Notes on replacing the secondary battery

- Do not remove the secondary battery from the watch. Replacement of the secondary battery requires professional knowledge and skill. Please ask the retailer from whom the watch was purchased for replacement of the secondary battery.
- Installation of an ordinary silver oxide battery can generate heat that can cause bursting and ignition.

EN 40

Daily care

● The watch requires good daily care

- Do not wash the watch when its crown is in the extended position.
 - Wipe away moisture, sweat or dirt with a soft cloth.
 - After soaking the watch in seawater, be sure to wash the watch in clean pure water and wipe it dry carefully. Do not pour running water directly from a faucet onto the watch. Put some water into a bowl first, and then soak the watch in the water to wash it.
- * If your watch is rated as "Non-water resistant" or "water resistant for daily use," please do not wash the watch. "Performance and type" → P.43
"Water resistant performance" → P.45

● Turn the crown from time to time

- In order to prevent corrosion of the crown, turn the crown from time to time.
- The same practice should be applied to a screw down crown. "Crown" → P.15

● Press the button once in a while

- Press the button once in a while to prevent corrosion of the button.

EN 42

* Overcharge prevention function

When the secondary battery is fully charged, the overcharge prevention function is automatically activated to avoid further charging.

There is no need to worry about damage caused by overcharging no matter how much the secondary battery is charged in excess of the "time required for fully charging the watch."

* For the required time to fully charge the battery, see "Guide to charging times" → P.38.

⚠ WARNING

■ Notes on charging the watch

- When charging the watch, do not place the watch in close proximity to an intense light source such as lighting equipment for photography, spotlights or incandescent lights, as the watch may be excessively heated resulting in damage to its internal parts.
- When charging the watch by exposure to direct sunlight, avoid places that easily reach high temperatures, such as a car dashboard.
- Always keep the watch temperature under 60°C.

EN 41

Performance and type

The case back shows the caliber and performance of your watch

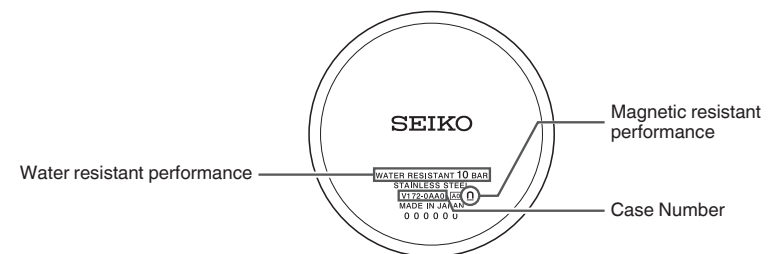

• Water resistant performance

Please refer to P.45.

• Case Number

The number to identify the type of your watch.

• Magnetic resistant performance

Please refer to P.46 and P.47.

* The above illustration is provided as an example, therefore it may not be exactly the same as your watch.

EN 43

Lumibrite

If your watch has Lumibrite

Lumibrite is a luminous paint that absorbs the light energy of sunlight and lighting apparatuses in a short time and stores it to emit light in the dark. For example, if exposed to a light of more than 500 lux for approximately 10 minutes, Lumibrite can emit light for 3 to 5 hours. Please note, however, that, as Lumibrite emits the light it stores, the luminance level of the light decreases gradually over time. The duration of the emitted light may also differ slightly depending on such factors as the brightness of the place where the watch is exposed to light and the distance from the light source to the watch.

* In general, when coming from a place that is bright to a place that is dark, it takes human eyes some time to adapt to the darkness making it difficult to see objects initially. (Dark adaptation)

* Lumibrite is luminous paint that stores and emits light, which is harmless to human beings and the environment, containing no toxic materials such as radioactive substances.

<Brightness levels>

Condition	Illumination
Sunlight	Fine weather 100,000 lux
	Cloudy weather 10,000 lux
Indoor (Window-side during daytime)	Fine weather More than 3,000 lux
	Cloudy weather 1,000 to 3,000 lux
	Rainy weather Less than 1,000 lux
Lighting apparatus (40-watt daylight fluorescent light)	Distance to the watch: 1 m 1,000 lux
	Distance to the watch: 3 m 500 lux (Average room luminance)
	Distance to the watch: 4 m 250 lux



Water resistant performance

Refer the table below for the description of water resistant performance of your watch before using. (Please look at P.43.)

Indication on the case back	Water resistant performance	Conditions of Use
No indication	Non-water resistance	Avoid drops of water or sweat
WATER RESISTANT	Water resistance for everyday life	The watch withstands accidental contact with water in everyday life. ⚠ WARNING Please do not use it for swimming.
WATER RESISTANT 5 BAR	Water resistance for everyday life at 5-BAR water resistant	The watch is suitable for sports such as swimming.
WATER RESISTANT 10 (20) BAR	Water resistance for everyday life at 10 (20)-BAR water resistant	The watch is suitable for diving not using an air cylinder.

Magnetic resistant performance

Affected by nearby magnetism,
a watch may temporarily gain or lose time or stop operating.

⚠ DANGER	
Indication on the case back	Condition of use
No indication	Keep the watch more than 10 cm away from magnetic products.
	Keep the watch more than 5 cm away from magnetic products. (JIS level-1 standard)
	Keep the watch more than 1 cm away from magnetic products. (JIS level-2 standard)

If the watch becomes magnetized and its accuracy deteriorates to an extent exceeding the specified rate under normal use, the watch needs to be demagnetized. In this case, you will be charged for demagnetization and accuracy readjustment even if it happens within the guarantee period.

The reason why a watch is affected by magnetism

The built-in motor is provided with a magnet, which may be influenced by a strong external magnetic field.

Examples of common magnetic products that may affect watches



Smartphone, cellular phone, tablet terminal
(Speaker, magnet of cover)



AC adapter



Bag
(With magnet buckle)



AC-powered shaver



Magnetic cooking device



Portable radio
(Speaker)



Magnetic necklace

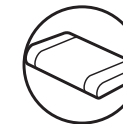

Magnetic health pillow

Band

The band touches the skin directly and becomes dirty with sweat or dust. Therefore, lack of care may accelerate deterioration of the band or cause skin irritation or stain on the sleeve edge. The watch requires a lot of attention for long usage.

● Metallic band

- Moisture, sweat or soil will cause rust even on a stainless steel band if they are left for a long time.
- Lack of care may result in a rash or cause a yellowish or gold stain on the lower sleeve edge of shirts.
- Wipe off moisture, sweat or soil with a soft cloth as soon as possible.
- To clean the soil around the joint gaps of the band, wipe it out in water and then brush it off with a soft toothbrush.
(Protect the watch body from water splashes by wrapping it up in plastic wrap etc.)
Clean it off with a soft cloth.
- Because some titan bands use pins made of stainless steel, which has outstanding strength, rust may form in the stainless steel parts.
- If rust advances, pins may poke out or drop out, and the watch case may fall off the band, or the clasp may not open.
- If a pin is poking out, personal injury may result. In such a case, refrain from using the watch and request repair.

EN 48

How to use tri-fold type clasp for leather band (Special clasps)

There are 3 types of special clasps as described below;
If the clasp of the watch you purchased is one of them, please refer to the indications.

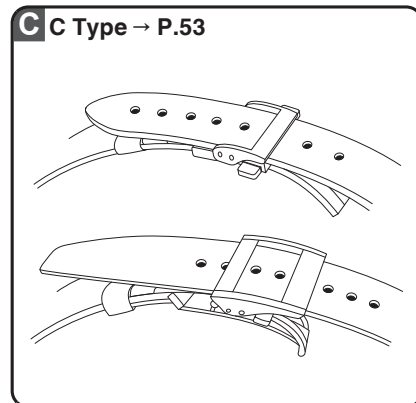
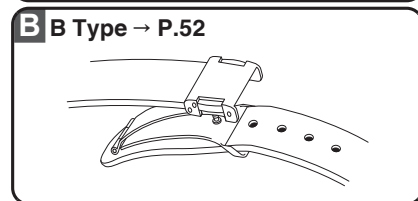
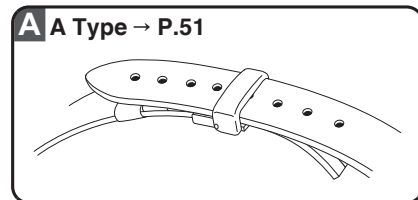

EN 50

● Leather band

- A leather band is susceptible to discoloration and deterioration from moisture, sweat and direct sunlight.
- Wipe off moisture and sweat as soon as possible by gently blotting them up with a dry cloth.
- Do not expose the watch to direct sunlight for a long time.
- Please take care when wearing a watch with light-colored band, as dirt is likely to show up.
- Refrain from wearing a leather band watch other than Aqua Free bands while bathing, swimming, and when working with water even if the watch itself is water resistant enforced for daily use (10-BAR/20-BAR water resistant).

● Polyurethane band

- A polyurethane band is susceptible to discoloration from light, and may be deteriorated by solvent or atmospheric humidity.
- Especially a translucent, white, or pale colored band easily adsorbs other colors, resulting in color smears or discoloration.
- Wash out dirt in water and clean it off with a dry cloth.
(Protect the watch body from water splashes by wrapping it up in plastic wrap etc.)
- When the band becomes less flexible, have the band replaced with a new one. If you continue to use the band as it is, the band may develop cracks or become brittle over time.

Notes on skin irritation and allergy	Skin irritation caused by a band may result from various factors such as allergy to metals or leathers, or skin reactions against friction on dust or the band itself.
Notes on the length of the band	Adjust the band to allow a little clearance with your wrist to ensure proper airflow. When wearing the watch, leave enough room to insert a finger between the band and your wrist.



EN 49

A A Type

- ① Lift up the clasp to release the buckle.

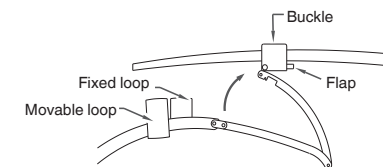

- ② Open the flap.

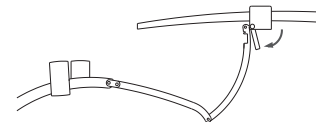

- ③ Remove the pin from the adjustment hole. Slide the band left and right, and reinsert the pin into the adjustment hole at an appropriate length.

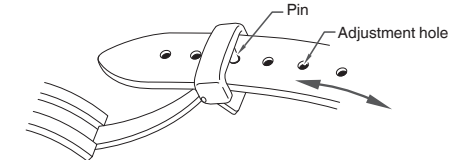

- ④ Fasten the flap.

* Do not push the flap in too hard.

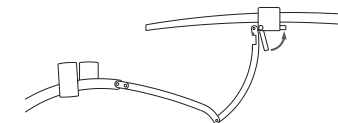

* When fastening the clasp, insert the tip of the band into the movable loop and fixed loop, and then, securely tighten the clasp.

EN 51

B Type

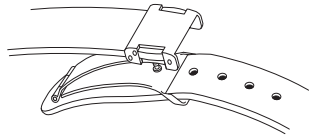

① While pressing the push buttons on both sides of the flap, lift to open the clasp.

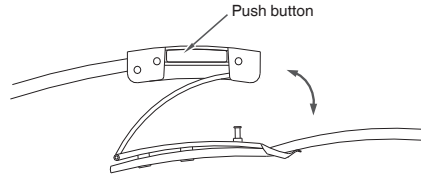

② Remove the pin from the adjustment hole. Slide the band left and right, and insert the pin into the adjustment hole at an appropriate length. Push the buckle and fasten the clasp.

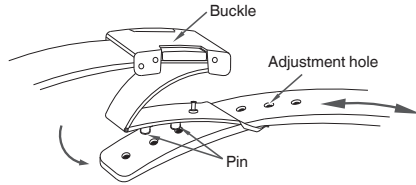

How to adjust the length of the band

① While pressing the push buttons on both sides of the flap, pull the band out of the movable loop and fixed loop. Then open the clasp.

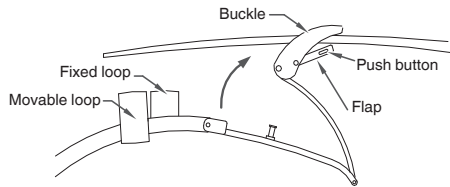

② Press the push buttons again to unfasten the flap.

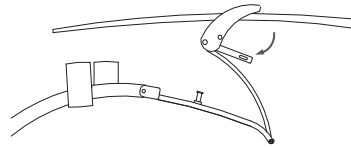

C Type

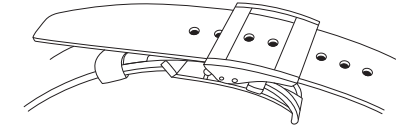
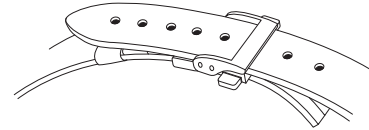

How to wear or take off the watch

① While pressing the push buttons on both sides of the flap, pull the band out of the movable loop and fixed loop. Then open the clasp.

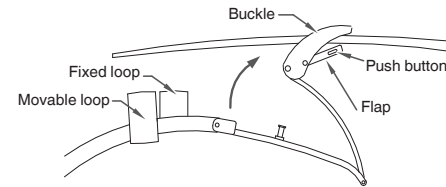

② Place the tip of the band into the movable loop and fixed loop, and fasten the clasp by pressing the frame of the buckle.

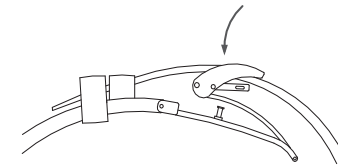

③ Pull the pin out of an adjustment hole of the band. Slide the band to adjust its length and find an appropriate hole. Place the pin into the hole.

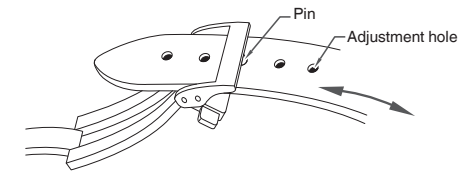

④ Fasten the flap.

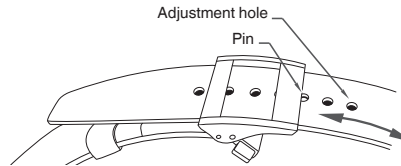
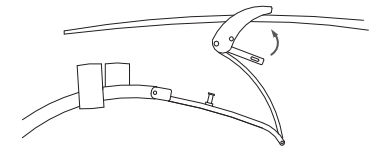

After sales service

● Notes on guarantee and repair

- Contact the retailer from whom the watch was purchased or SEIKO CUSTOMER SERVICE CENTER for repair or overhaul.
- Within the guarantee period, present the certificate of guarantee to receive repair services.
- Guarantee coverage is provided in the certificate of guarantee. Read carefully and retain it.
- For repair services after the guarantee period has expired, if the functions of the watch can be restored by repair work, we will undertake repair services upon request and payment.

● Replacement with functional parts

- Please keep in mind that if original parts are not available, they may be replaced with substitutes whose outward appearance may differ from the originals.

EN 56

Adjusting the preliminary position of the stopwatch hands

If any of the stopwatch hands do not return to the 0 minute 0 second position when the stopwatch is reset, the preliminary hand position may be misaligned.

The reference position of the stopwatch needle is [0 second · 0 minute] (V172 · V174 · V175) or [00 second · 0 second · 0 minute] (V176) respectively.

Adjusting the hands to the preliminary position will ensure that stopwatch measurements are correct.

The preliminary position may be misaligned due to the following reasons.

- In the case of a strong impact: Misalignment may occur when dropping or hitting the watch.
- In the case of a magnetic influence: Misalignment may occur when bringing the watch close to an object which generates magnetism.

"Examples of common magnetic products that may affect watches" → P.47

* If the preliminary position adjustment is carried out, the watch gains or loses time. After adjusting the preliminary hand position, make sure to reset the main time and alarm time.

EN 58

● Inspection and adjustment by disassembly and cleaning (Overhaul)

- Periodic inspection and adjustment by disassembly and cleaning (overhaul) is recommended approximately once every 3 to 4 years in order to maintain optimal performance of the watch for a long time. According to use conditions, the oil retaining condition of your watch mechanical parts may deteriorate, abrasion of the parts may occur due to contamination of oil, which may ultimately lead the watch itself to stop. As the parts such as gasket may deteriorate, water-resistant performance may be impaired due to intrusion of perspiration and moisture. Please contact the retailer from whom the watch was purchased for inspection and adjustment by disassembly and cleaning (overhaul). For replacement of parts, please specify "SEIKO GENUINE PARTS." When asking for inspection and adjustment by disassembly and cleaning (overhaul), make sure that the gasket and push pin are also replaced with new ones.
- When your watch is inspected and adjusted by disassembly and cleaning (overhauled), the movement of your watch may be replaced.

EN 57

■ Adjusting the preliminary position of the stopwatch 1/5-second and minute hands (V172, V174, V175)

1 Make sure that the watch is working.

Check that the seconds hand is moving at one-second intervals.

If the seconds hand is moving at two-second intervals or the seconds hand has stopped, charge the watch by exposing the dial of the watch to light. "Charging the battery" → P.37

2 Pull out the crown to the second click.

The seconds hand will stop.

* For models with screw down crown, please unlock the crown before operating it.

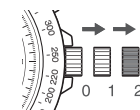

Pull out the crown to the second click.

EN 59

3 Press and hold button A (for 3 seconds) until the stopwatch minute hand starts moving.

The stopwatch minute hand moves one full rotation, and the watch enters the preliminary position adjustment mode of the stopwatch minute hand.

* If you do not know which hand is the stopwatch minute hand, refer to "Names of the parts and functions" → P.10, 11, 12, 13.

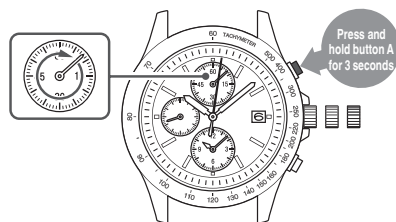

4 Press button B to reset the stopwatch minute hand to 0 minute.

One minute Advance	Press button B once and then release it.
Continuous Advance	When button B is kept pressed for two seconds or longer, the hand will start moving. When button B is released, the hand will stop.

* If the stopwatch minute hand is reset to 0 minute, continue to procedure 5

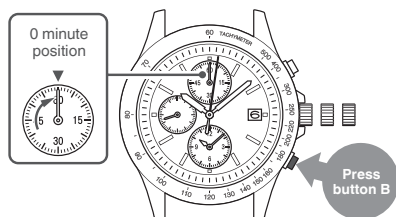

7 Push the crown back in to the normal position.

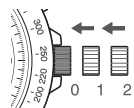

8 Set the main time and alarm time.

"How to set the time and date" → P.17

If the preliminary position adjustment is carried out, the main time and alarm time may gain or lose time. When the main time and alarm time are set, the operation is completed.

5 Press and hold button A (for 3 seconds) until the stopwatch 1/5-second hand starts moving.

The stopwatch 1/5-second hand moves one full rotation, and the watch enters the preliminary position adjustment mode of the stopwatch 1/5-second hand.



6 Press button B to set the stopwatch 1/5-second hand to 0 seconds.

1/5-second Advance	Press button B once and then release it.
Continuous Advance	When button B is kept pressed for two seconds or longer, the hand will start moving. When button B is released, the hand will stop.

* If the stopwatch 1/5-second hand is reset to 0 second, continue to procedure 7

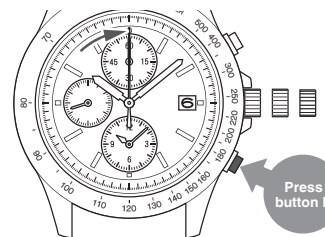

■ Adjusting the preliminary position of the stopwatch 1/20-second, second and minute hands (V176)

1 Make sure that the watch is working.

Check that the seconds hand is moving at one-second intervals.

If the seconds hand is moving at two-second intervals or the seconds hand has stopped, charge the watch by exposing the dial of the watch to light. "Charging the battery" → P.37

2 Pull out the crown to the second click.

The seconds hand will stop.

* For models with screw down crown, please unlock the crown before operating it.

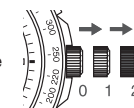

Pull out the crown to the second click.

3 Press and hold button A (for 3 seconds) until the stopwatch 1/20-second hand starts moving.

The stopwatch 1/20-second hand moves one full rotation, and the watch enters the preliminary position adjustment mode of the stopwatch 1/20-second hand.

* If you do not know which hand is the stopwatch 1/20-second hand, refer to “Names of the parts and functions” → P.14.

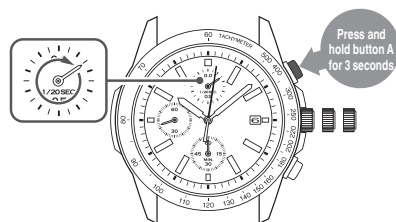

4 Press button B to reset the stopwatch 1/20-second hand to 00.

1/20 second Advance	Press button B once and then release it.
Continuous Advance	When button B is kept pressed for two seconds or longer, the hand will start moving. When button B is released, the hand will stop.

* If the stopwatch 1/20-second hand is reset to 00, continue to procedure 5.

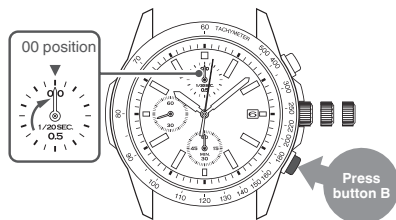

5 Press and hold button A (for 3 seconds) until the stopwatch second hand starts moving.

The stopwatch second hand moves one full rotation, and the watch enters the preliminary position adjustment mode of the stopwatch second hand.



6 Press button B to reset the stopwatch second hand to 0 second.

One second Advance	Press button B once and then release it.
Continuous Advance	When button B is kept pressed for two seconds or longer, the hand will start moving. When button B is released, the hand will stop.

* If the stopwatch 1/5-second hand is reset to 0 second, continue to procedure 7

7 Press and hold button A (for 3 seconds) until the stopwatch minute hand starts moving.

The stopwatch minute hand moves one full rotation, and the watch enters the preliminary position adjustment mode of the stopwatch minute hand.

8 Press button B to reset the stopwatch minute hand to 0 minute.

One minute Advance	Press button B once and then release it.
Continuous Advance	When button B is kept pressed for two seconds or longer, the hand will start moving. When button B is released, the hand will stop.

* If the stopwatch minute hand is reset to 0 minute, continue to the procedure 9.

9 Set the main time.

“How to set the time and date” → P.17

If the preliminary position adjustment is carried out, the main time may gain or lose time. When the main time is set, the operation is completed.

10 Push the crown back in to the normal position.

Troubleshooting

Troubles	Possible causes	Solutions	Reference
The watch stops operating.	The power is completely depleted or low.	Sufficiently charge the battery until the seconds hand moves every second.	P.37
The seconds hand is moving at two-second intervals.	If you wear the watch every day and this occurs, the most likely cause is the watch is hidden by your sleeves or other clothing when you wear it and it is not sufficiently exposed to light.	When you wear the watch, try to make sure that the watch is not hidden by your sleeves or other clothing. Additionally, when you take the watch off, try to place it in a bright place.	
The stopped watch was exposed to an adequate light for longer than “the time required to fully charge the watch,” however, it does not resume its normal one-second interval movements or even does not start operating.	The internal watch system is unstable. The light is too weak. More time is required to fully charge the watch.	See “Resetting the built-in IC” and follow the procedure. The time taken to charge will differ depending on the light intensity. For details on charging times, see “Guide to charging times”. If the hands still fail to resume operation, follow the procedure of “Resetting the built-in IC”.	P.70 P.38 P.70

Troubles	Possible causes	Solutions	Reference
The watch temporarily gains/loses time.	The watch has been left in extremely high or low temperatures for a long time.	If the watch returns to room temperature, the accuracy will return to its original state. If it does not return to its original state, contact the retailer from whom the watch was purchased.	-
	The watch has been left close to an object with a strong magnetic field.	Correct this condition by moving and keeping the watch away from the magnetic source, and reset the time. If this action does not correct the condition, contact the retailer from whom the watch was purchased.	-
	You drop the watch, hit it against a hard surface, or wear it while playing active sports. The watch is exposed to strong vibrations.	If accuracy does not return after setting the time, consult the retailer from whom the watch was purchased.	-
Any of the stopwatch hands do not return to the 0 minute 0 second position when the stopwatch is reset.	Any of the stopwatch hands are out of the preliminary position. This happens when the stopwatch hands are out of the preliminary position as a result of influence of various external sources or after the built-in IC is reset.	Adjust the preliminary position of stopwatch hands.	P.58

If the hands fail to move or move abnormally even after recharging

When the watch shows an abnormal display or does not properly function, or does not move at all or at one-second intervals even after being fully charged, follow the instructions below to reset the built-in IC. Then the watch will resume its normal operation.

Resetting the built-in IC

1 Pull out the crown to the second click.

The seconds hand will stop.

* For models with screw down crown, please unlock the crown before operating it.

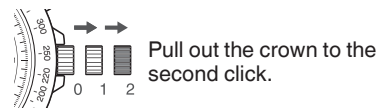

2 Press and hold buttons A and B simultaneously for three seconds, and release.

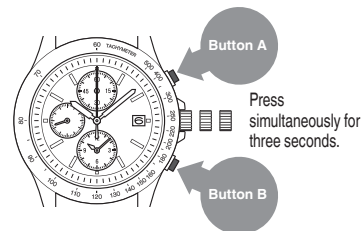

Troubles	Possible causes	Solutions	Reference
Although the alarm time has not been set, the displayed alarm time is different from the main time. The buttons cannot be operated (cannot be pushed when trying to do so).	The watch is left close to an object with a strong magnetic field, hit hard, or exposed to strong shocks or vibrations.	Reset the time of the main time and alarm time.	P.17
The buttons do not work (Nothing happens when they are pressed).	The power is low.	Sufficiently charge the battery until the seconds hand moves every second.	P.37
The date changes at 12 o'clock noon.	AM/PM is not properly set.	Advance the hands by 12 hours.	P.17
Blur in the display persists.	A small amount of water has got inside the watch due to deterioration of the gasket, etc.	Consult the retailer from whom the watch was purchased.	-

* Contact the retailer from whom the watch was purchased for any other troubles.

3 Push the crown back in to the normal position.

The seconds hand immediately starts moving.

If the seconds hand is moving at two-second intervals, fully charge the watch until it starts moving at one-second intervals. → P.37

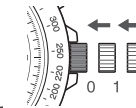

4 Adjust the preliminary position of the stopwatch hands, and then set the time and date.

- [Adjusting the preliminary position of the stopwatch hands](#) → P.58
- [How to set the time and date](#) → P.17

When the preliminary position of the stopwatch hands are reset, and time and date are correctly set, the operation of resetting the built-in IC is completed.

Specifications

Caliber number	V172	V174	V175	V176
1. Features	Main time with 3 hands (hour, minute, second) Date display Stopwatch (1/5-second and minute hands) Small alarm display (hour and minute hands)	Main time with 3 hands (hour, minute, second) 24-hour hand Date display Stopwatch (1/5-second and minute hands) Small alarm display (hour and minute hands)	Main time with 3 hands (hour, minute, second) 24-hour hand Date display Stopwatch (1/5-second and minute hands)	Main time with 3 hands (hour, minute, second) Date display Stopwatch (1/20-second, second and minute hands)
2. Frequency of crystal oscillator	32,768 Hz (Hz= Hertz, cycles per second)			
3. Loss/gain (Monthly rate)	Loss / gain ± 15 seconds on a monthly rate (Except the case when the watch is used without an automatic time setting by receiving a radio signal and when it is worn on the wrist within a normal temperature range between 5°C and 35°C).			
4. Operational temperature range	-10 °C ~ +60 °C			
5. Driving system	Step Motor, 4 pieces		Step Motor, 3 pieces	Step Motor, 4 pieces
6. Power source	Secondary battery, 1 piece			
7. Duration	Approx. 6 months (if the stopwatch is used for 1 hour per day, and the alarm is used one time to sound for 20 seconds per day)			Approx. 6 months (if the stopwatch is used for 1 hour per day)
8. IC (Integrated Circuit)	Oscillator, frequency divider and driving circuit C-MOSIC, 1 piece			

* The specifications are subject to change without prior notice due to product improvements.